

ÜBERSICHTSZEICHNUNG
ASSEMBLY DRAWING

LAPIERRE

OVERVOLT HT



E-EXPLORER



OVERVOLT HT 9.7 / 9.7 MIX (MY22)

E-EXPLORER 9.7 / 9.7 MIX / 8.7 / 8.7 MIX (MY22)

Datum: 08-12-2022

Version: 02





OVERVOLT HT 9.7 / 9.7 MIX / E-EXPLORER 9.7 / 9.7 MIX / 8.7 / 8.7 MIX (MY22)

date: 08-12-2022

version: 02

HOW TO USE EXPLODED VIEW

BOM-ID	Description	Specification	Torque	QTY	Service Kit nr.
1	Counter sunk screw (Set)	IS2 - M3 x 8 mm	1 Nm	2	KHB00025  

“ You can click on the logo according to your part's supplier. It will take you to the purchase page. ”



A screenshot of a web browser showing a product page. The browser's address bar contains 'KHB00025'. The page header includes navigation menus for 'Commander', 'Info commandes', 'Service', 'Actu', 'Bilsons personnalisés', 'Aide Accentry', and 'Offres'. Below the header is a breadcrumb trail: 'Accueil / Rechercher / Vélos / Service Kits / JEU DE SUPPORTS ENTRÉE DE CÂBLES MOTEUR YAMAHA E-BIKE HAIBIKE ALLTRACK GAUCHE/DROITE NOIR'. The main content area features an image of the product, which consists of two black plastic cable inlet supports and five small metal screws. To the right of the image, the product title is 'JEU DE SUPPORTS ENTRÉE DE CÂBLES MOTEUR YAMAHA E-BIKE HAIBIKE ALLTRACK GAUCHE/DROITE NOIR 2023'. Below the title, it says 'TRK ALLTRACK YAMAHA CABLE INLET SET' and lists the included items: 'Comprend: support d'entrée de câbles gauche et droite, vis.' The product details include 'Numéro d'article: KHB00025', 'Code-barres: 8715957603410', and 'Référence fournisseur: KHB00025'. A green 'Stock ✓' indicator is present. The price is listed as 'Prix public € 9,99'. At the bottom, there is a quantity selector set to '1' and a blue 'Commander' button.

ÜBERSICHTSZEICHNUNG

ASSEMBLY DRAWING main frame

LAPIERRE

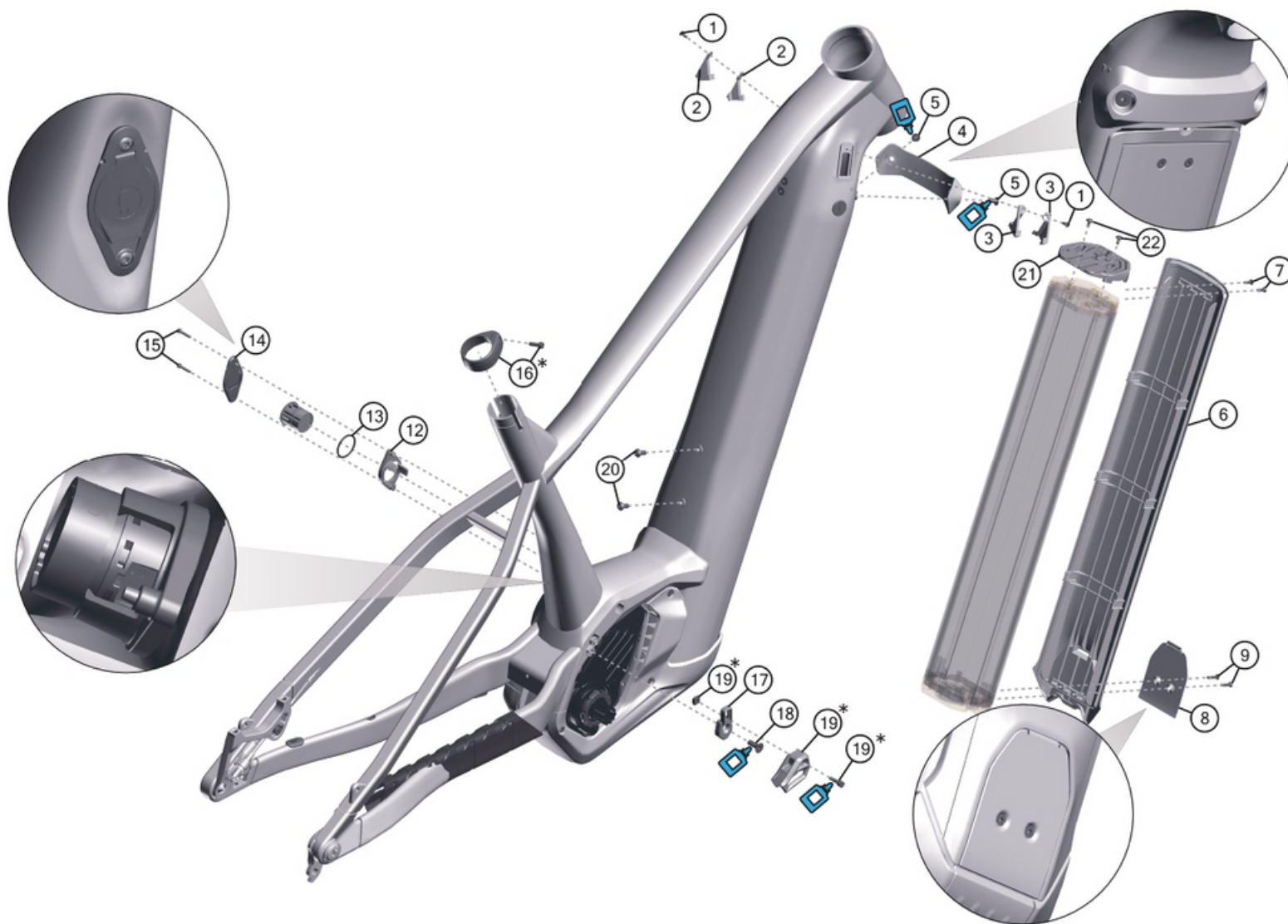

Hinweis: Bei den Schrauben muss mittelfeste Gewindesicherung verwendet werden. Rote Flächen müssen gefettet werden.

Note: use medium strength screw lock for screw threads. red surfaces has to be greased.

 > medium strength screwlock







































OVERVOLT HT 9.7 / 9.7 MIX / E-EXPLORER 9.7 / 9.7 MIX / 8.7 / 8.7 MIX (MY22)
 date: 08-12-2022
 version: 02



ÜBERSICHTSZEICHNUNG

ASSEMBLY DRAWING main frame

LAPIERRE

BOM-ID	Description	Specification	Torque	Service kit	QTY
1	Counter sunk screw	IS2 - M3 x 8 mm	1 Nm	KHB00035  	2
2	Cable inlets left side			KHB00035  	2
3	Cable inlets right side			KHB00035  	2
4	Fork bumper			KLP00031  	1
5	Cylinder head screw	IS4 - M5 x 8 mm	6 Nm	KLP00031  	2
6	Battery cover			KLP00033  	1
7	Counter sunk screw	IS2 - M3 x 12 mm	1 Nm	KLP00033  	2
8	Battery metal skidplate			KLP00033  	1
9	Counter sunk screw (stainless steel)	IS2 - M3 x 18 mm	1 Nm	KLP00033  	2
12	Charge port frame			KHB00075  	1
13	O-ring charge port			KHB00075  	1
14	Charge port cover			KHB00075  	1
15	Lens head screw	TX10 - M3 x 16 mm	1 Nm	KLP00017  	2
16	Seatclamp (incl. cylinder head screw)	Ø 34,9 mm		 	1
17	Chain guide bracket			KLP00059  	1
18	Lens head screw (stainless steel)	IS4 - M6 x 10 mm	11 Nm	KLP00059  	1
19*	Chain guide (set incl. screw and nut)			KLP00059  	1
19*	Cylinder head screw (set incl. chain guide and nut)	IS3 - M4 x 10 mm	3 Nm	KLP00059  	1
19*	Square nut (set incl. chain guide and screw)	M4		KLP00059  	1
20	Lens head screw	IS3 - M5 x 12 mm	6 Nm		2
21	Screw-on plate			Bosch EB12.100.01E	1
22	Screw for screw-on plate	T15 - M3 x 7 mm	1.2 Nm	Bosch EB12.100.01G	2

OVERVOLT HT 9.7 / 9.7 MIX / E-EXPLORER 9.7 / 9.7 MIX / 8.7 / 8.7 MIX (MY22)

date: 08-12-2022

version: 02



ÜBERSICHTSZEICHNUNG

ASSEMBLY DRAWING

battery mount

LAPIERRE

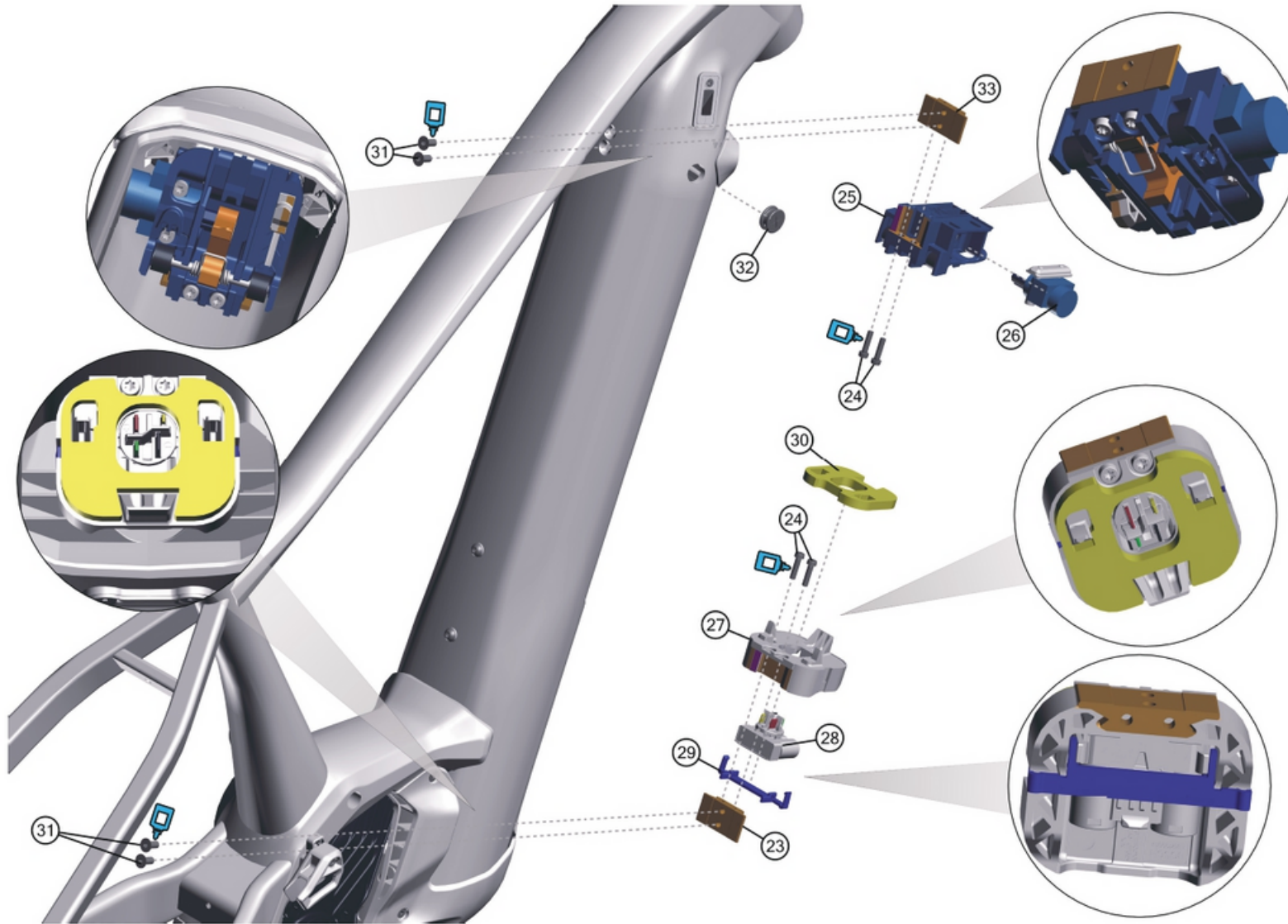

Hinweis: Bei den Schrauben muss mittelfeste Gewindesicherung verwendet werden. Rote Flächen müssen gefettet werden.

Note: use medium strength screw lock for screw threads. red surfaces has to be greased.



> medium strength screwlock

OVERVOLT HT 9.7 / 9.7 MIX / E-EXPLORER 9.7 / 9.7 MIX / 8.7 / 8.7 MIX (MY22)

date: 08-12-2022















version: 02



ÜBERSICHTSZEICHNUNG

ASSEMBLY DRAWING battery mount

LAPIERRE

BOM-ID	Description	Specification	Torque	Service kit	QTY
23	Battery holder adapter			KLP00060  	1
24	Screw for battery holder adapter	T20 - M4 x 16 mm	3 Nm	KLP00022  	4
25	Locking assembly			KLP00019  	1
26	Battery lock	IT3 XPLUS		KLP00060  	1
27	Cradle			Bosch EB12.100.01U	1
28	Battery adapter			Bosch EB12.100.015	1
29	Clamp ring			Bosch EB12.100.02D	1
30	Damper foil poron plug			Bosch EB12.100.01Z	1
31	Counter sunk screw	IS3 - M5 x 12 mm	6 Nm	KLP00060  	4
32	Rubber ring			KLP00028  	1
33	Battery holder adapter top			KLP00060  	1



OVERVOLT HT 9.7 / 9.7 MIX / E-EXPLORER 9.7 / 9.7 MIX / 8.7 / 8.7 MIX (MY22)

date: 08-12-2022

version: 02

ÜBERSICHTSZEICHNUNG

ASSEMBLY DRAWING

motor cover

LAPIERRE

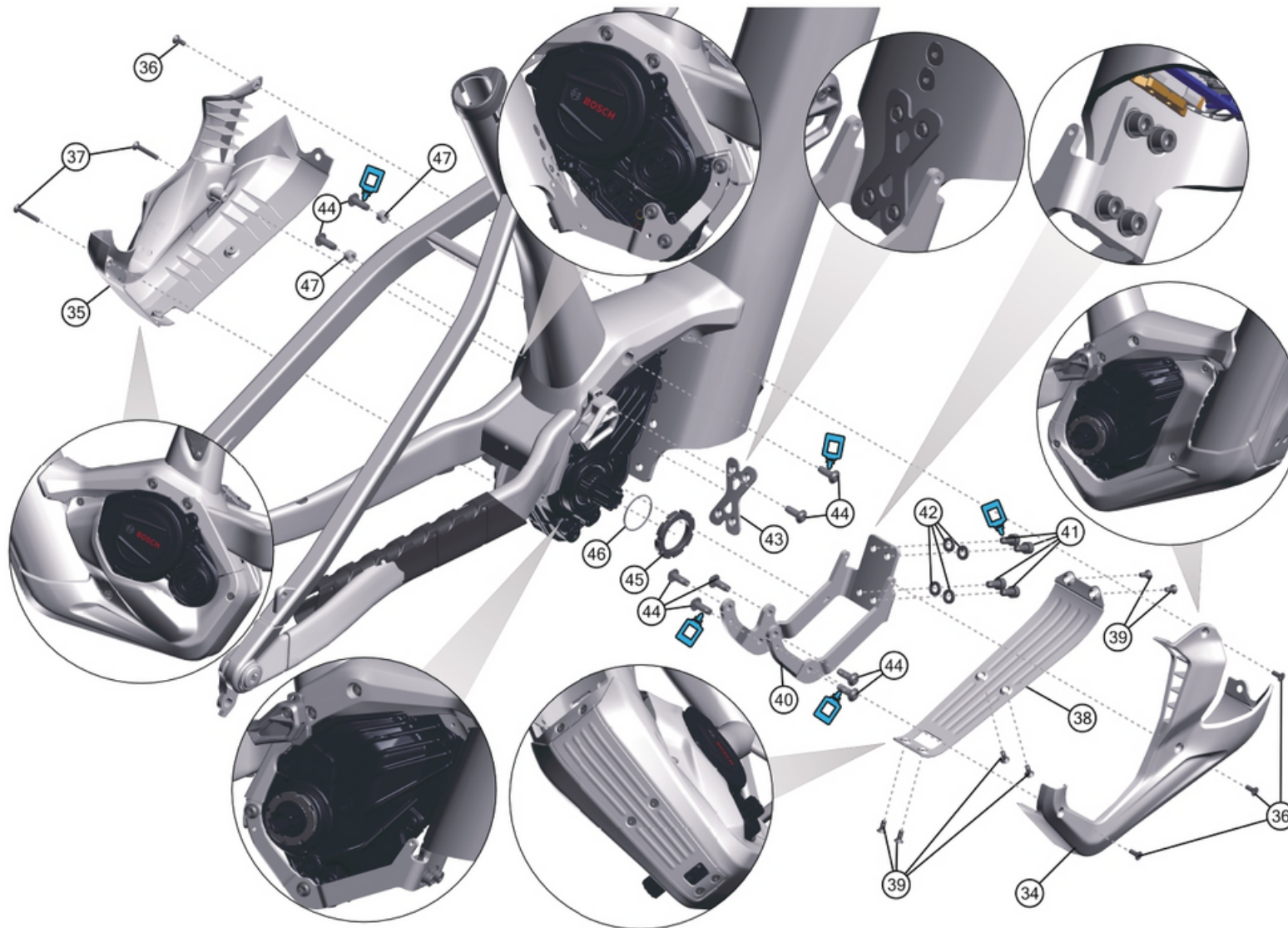

Hinweis: Bei den Schrauben muss mittelfeste Gewindesicherung verwendet werden. Rote Flächen müssen gefettet werden.

Note: use medium strength screw lock for screw threads. red surfaces has to be greased.



> medium strength screwlock

OVERVOLT HT 9.7 / 9.7 MIX / E-EXPLORER 9.7 / 9.7 MIX / 8.7 / 8.7 MIX (MY22)

date: 08-12-2022























version: 02



ÜBERSICHTSZEICHNUNG

ASSEMBLY DRAWING motor cover

LAPIERRE

BOM-ID	Description	Specification	Torque	Service kit	QTY
34	Motor cover right			KLP00033  	1
35	Motor cover left			KLP00033  	1
36	Counter sunk screw	IS2.5 - M4 x 12 mm	3 Nm	KLP00033  	4
37	Counter sunk screw	IS2.5 - M4 x 25 mm	3 Nm	KLP00033  	2
38	Motor metal skidplate			KLP00033  	1
39	Counter sunk screw (stainless steel)	IS2.5 - M4 x 10 mm	3 Nm	KLP00033  	6
40	Motor bracket			KLP00061  	1
41	Cylinder head screw (flat head)	IS4 - M6 x 14 mm	11 Nm	KLP00061  	4
42	Washer (stainless steel)	Ø 6,4		KLP00061  	4
43	Motor bracket Xplate			KLP00061  	1
44	Screw for mounting connection plate	T30 - M6 x 16 mm	13 Nm	Bosch EB11.200.00P	9
45	Lockring for BDU4XX			Bosch 1270.014.085	1
46	O-Ring			Bosch 1270.016.119	1
47	Motor bushing			KLP00061  	2

OVERVOLT HT 9.7 / 9.7 MIX / E-EXPLORER 9.7 / 9.7 MIX / 8.7 / 8.7 MIX (MY22)

date: 08-12-2022

version: 02



ÜBERSICHTSZEICHNUNG

ASSEMBLY DRAWING rear frame

LAPIERRE

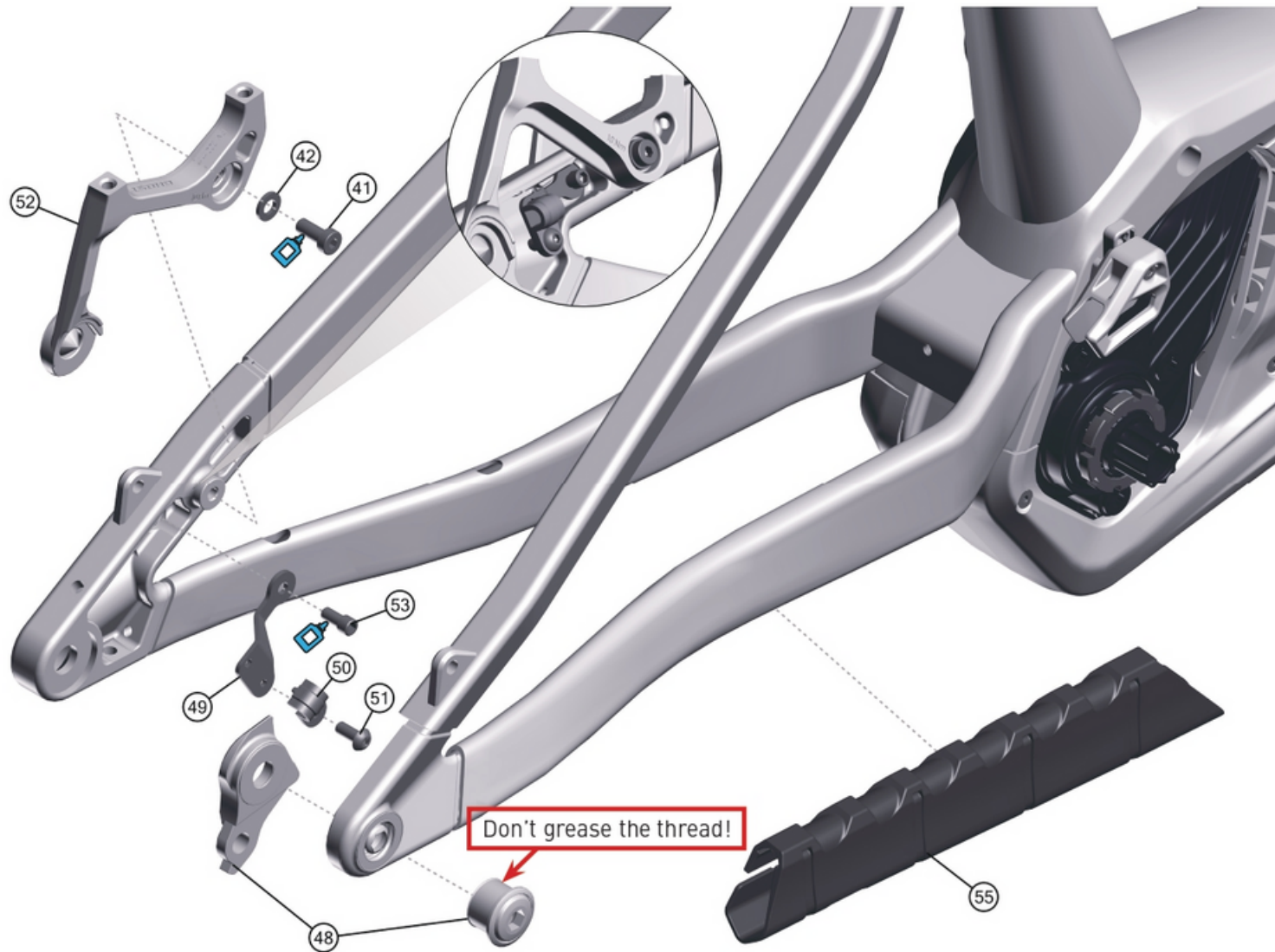

Hinweis: Bei den Schrauben muss mittelfeste Gewindesicherung verwendet werden. Rote Flächen müssen gefettet werden.

Note: use medium strength screw lock for screw threads. red surfaces has to be greased.



> medium strength screwlock



OVERVOLT HT 9.7 / 9.7 MIX / E-EXPLORER 9.7 / 9.7 MIX / 8.7 / 8.7 MIX (MY22)













date: 08-12-2022

version: 02

ÜBERSICHTSZEICHNUNG

ASSEMBLY DRAWING rear frame

LAPIERRE

BOM-ID	Description	Specification	Torque	Service kit	QTY
41	Cylinder head screw (flat head)	IS4 - M6 x 14 mm	11 Nm	KLP00058  	1
42	Washer (stainless steel)	Ø 6,4		KLP00058  	1
48	UDH derailleur hanger + nut	Don't grease the thread!	25 Nm		1
49	Sensor bracket			KLP00035  	1
50	Clip holder			Bosch 1270.016.038	1
51	Screw for clip holder			Bosch 1270.016.148	1
52	Rear brake mount adapter			KLP00058  	1
53	Lens head screw	TX25 - M5 x 8 mm	6 Nm	KLP00035  	1
55	Chainstay protector			KLP00030  	1

OVERVOLT HT 9.7 / 9.7 MIX / E-EXPLORER 9.7 / 9.7 MIX / 8.7 / 8.7 MIX (MY22)

date: 08-12-2022

version: 02



ÜBERSICHTSZEICHNUNG

ASSEMBLY DRAWING

E-EXPLORER carrier and fender

LAPIERRE

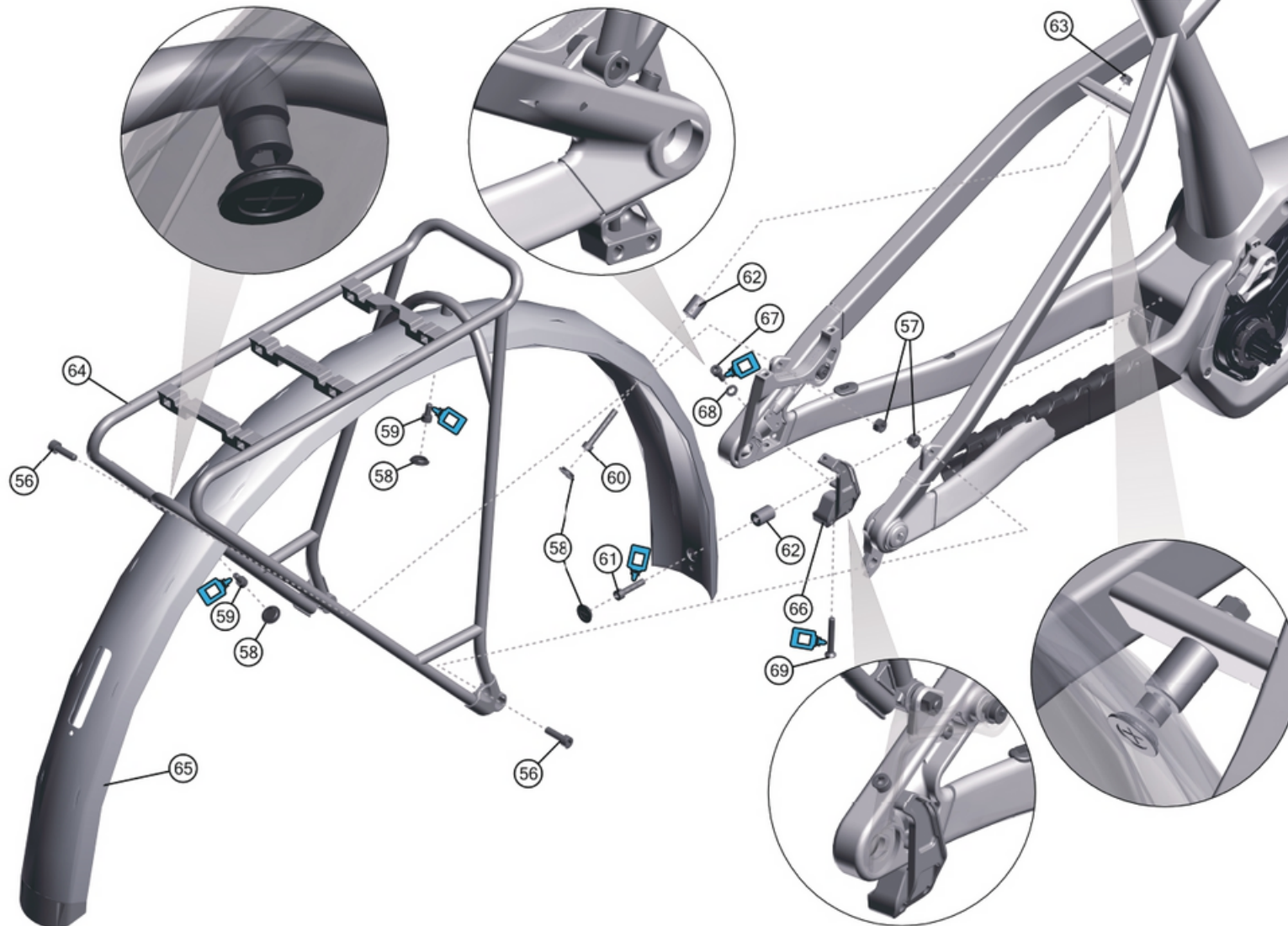

Hinweis: Bei den Schrauben muss mittelfeste Gewindesicherung verwendet werden. Rote Flächen müssen gefettet werden.

Note: use medium strength screw lock for screw threads. red surfaces has to be greased.



> medium strength screwlock



OVERVOLT HT 9.7 / 9.7 MIX / E-EXPLORER 9.7 / 9.7 MIX / 8.7 / 8.7 MIX (MY22)









date: 08-12-2022

version: 02

ÜBERSICHTSZEICHNUNG

ASSEMBLY DRAWING E-EXPLORER carrier and fender

LAPIERRE

BOM-ID	Description	Specification	Torque	Service kit	QTY
56	Cylinder head screw	IS5 - M6 x 20 mm	11 Nm	KLP00036  	2
57	Self locking nut	M6		KLP00036  	2
58	Mudguard plastic plug	Ø 12 mm		KLP00029  	4
59	Mudguard cylinder head screw	IS4 - M5 x 10 mm	6 Nm	KLP00029  	2
60	Mudguard cylinder head screw	IS4 - M5 x 35 mm	6 Nm	KLP00029  	1
61	Mudguard cylinder head screw	IS4 - M5 x 25 mm	6 Nm	KLP00029  	1
62	Mudguard spacer	Ø 12 x 5,5 x 17 mm		KLP00029  	2
63	Mudguard self locking nut with flange	M5		KLP00029  	1
64	Carrier 27,5 I-CARUS			KLP00036  	1
65	Mudguard Set 27,5			KLP00029  	1
66	Kickstand adaptor			KLP00057  	1
67	Cylinder head screw (flat head)	TX25 - M5 x 14 mm	6 Nm	KLP00057  	1
68	Washer	Ø 5,3 mm		KLP00057  	1
69	Counter sunk screw	TX25 - M5 x 35 mm	6 Nm	KLP00057  	1

OVERVOLT HT 9.7 / 9.7 MIX / E-EXPLORER 9.7 / 9.7 MIX / 8.7 / 8.7 MIX (MY22)

date: 08-12-2022

version: 02



ÜBERSICHTSZEICHNUNG

ASSEMBLY DRAWING

LAPIERRE

FACT SHEET:	
SHOCK LENGTH:	-----
SHOCK HARDWARE TOP:	-----
SHOCK HARDWARE BOTTOM:	-----
HEADSET TOP:	ZS 56
HEADSET BOTTOM:	ZS 56
SEATPOST DIAMETER:	31,6 MM
CLAMP INNER DIAMETER:	34,9 MM
BOTTOM BRACKET:	-----
KICKSTAND:	KSA 18 (Adapter required)
ISCG STANDARD:	-----
CARRIER MOUNT:	YES
FENDER COMPATIBLE:	YES

DROPPER SEATPOST READY:	YES
WATERBOTTLE MOUNT:	1x 0,75 L
MAXIMUM PERMISSIBLE TOTAL WEIGHT:	120 KG
MAXIMUM TIRE SIZE:	
WHEEL SIZE:	Size S: 27,5" Size M / L / XL: 29"
QUICK RELEASE LENGTH:	180 MM
OVER-LOCKNUT DIMENSION (O.L.D.):	148 MM
FD CLAMP SIZE:	-----
FD TYPE:	-----
ENGINE:	BOSCH PERFORMANCE LINE CX
BATTERY:	BOSCH POWERTUBE 750WH
DISPLAY:	BOSCH LED REMOTE BOSCH KIOX

OVERVOLT HT 9.7 / 9.7 MIX / E-EXPLORER 9.7 / 9.7 MIX / 8.7 / 8.7 MIX (MY22)

date: 08-12-2022

version: 02

